

AP MINUTEMAN™

Repeater Enclosure

Owner's Manual



THIS PAGE INTENTIONALLY LEFT BLANK

Table of Contents

Contacting Us	4
Safety First	5
Product Overview	6
Product Specifications	8
Installation	12
Appendix A	14
Technical Support	14
Warranty Policy	14

Contacting Us

American Products can be contacted for any issues that arise with the supplied product.

Technical assistance is available 9am to 4pm central standard time.

- Toll Free: (855) 736-2135
- Phone: (417) 736-2135
- Fax: (417) 736-9535
- Email: Sales@amprod.us
- Web: www.amprod.us

When calling, please have available, or if faxing or emailing, be sure to provide:



- Part Number _____
- Serial Number _____
- Date of Purchase _____
- Date of Installation _____

Safety First

This publication provides a description of the American Products AP MINUTEMAN™ Enclosure. The mechanical descriptions, typical applications, installation instructions, safety guidelines, grounding and bonding are included.

Four types of messages may appear throughout this manual, identified by the following icons and signal words:

	Read equipment manufacturer’s manual and this material before using this product. Failure to do so can result in serious injury or death.
---	---

 DANGER	Indicates a hazardous situation that, if not avoided, will result in death or serious injury. This signal word is to be limited to the most extreme situations.
 WARNING	Indicates a hazardous situation that, if not avoided, could result in death or serious injury.
 CAUTION	Indicates a hazardous situation that, if not avoided, could result in minor or moderate injury.
NOTICE:	Indicates information considered important, but not hazard-related (e.g. messages relating to property damage). The safety alert symbol shall not be used with this signal word. When a signal word is used for messages relating to property damage, NOTICE is the choice of signal word.



Product Overview

- The AP MINUTEMAN™ cabinet is constructed of 12GA, 18GA and 20GA Galvanized Steel with GR487 Compliant powder coat painted finish for reduced weight and superior corrosion resistance. The front and rear doors are equipped with a keyed 1/4 turn pawl mechanism for added security. The top of the cabinet has a double wall construction to reduce the effects of solar radiation and for structural integrity.
- AP MINUTEMAN™ has a 600lb static distributed weight load capacity. A 2nd set of rack rails (optional purchase) is recommended to evenly distribute the weight of your equipment.
- The Cabinet is designed to allow various accessories to be mounted in the enclosure to meet customer requirements. For part number structure for Parent enclosure and accessories see diagram below:

PART NUMBERING EXAMPLE

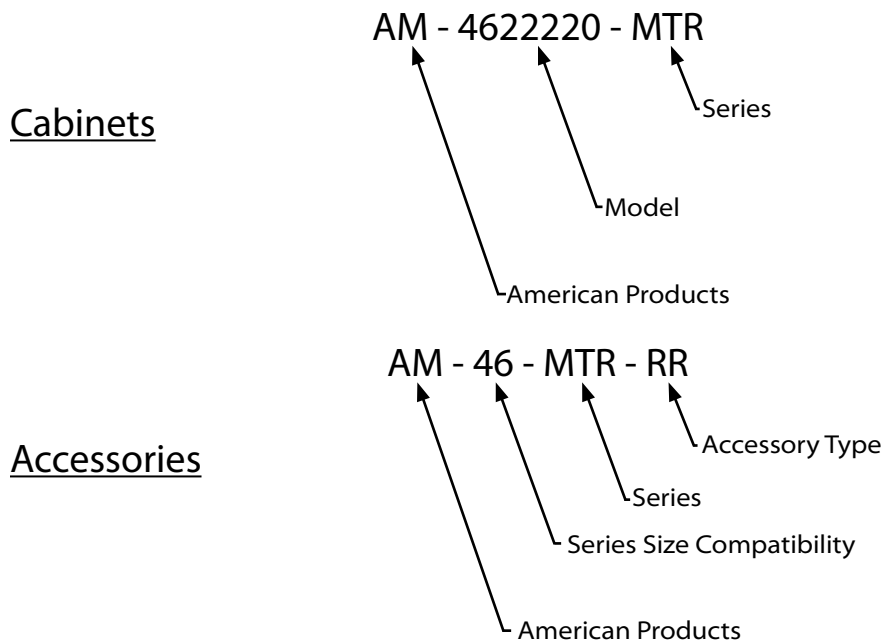

THIS PAGE INTENTIONALLY LEFT BLANK

Product Specifications

AM-122220-MTR (5RU)

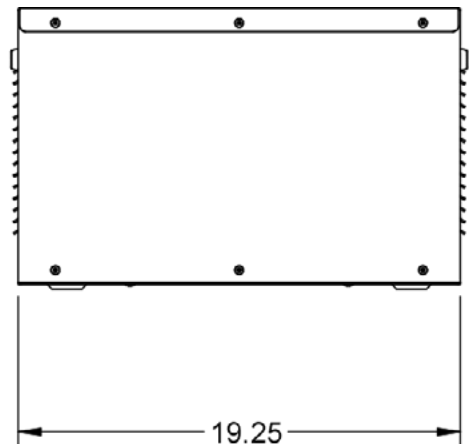
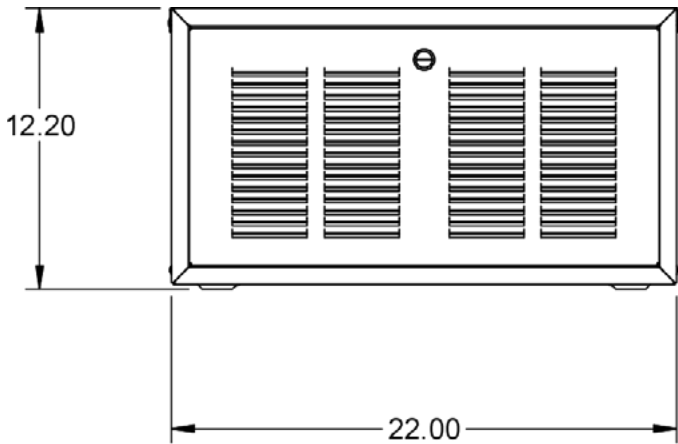

AM-122224-MTR (5RU)

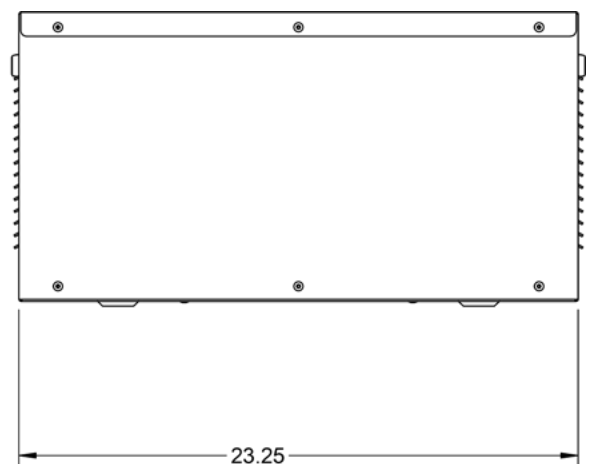
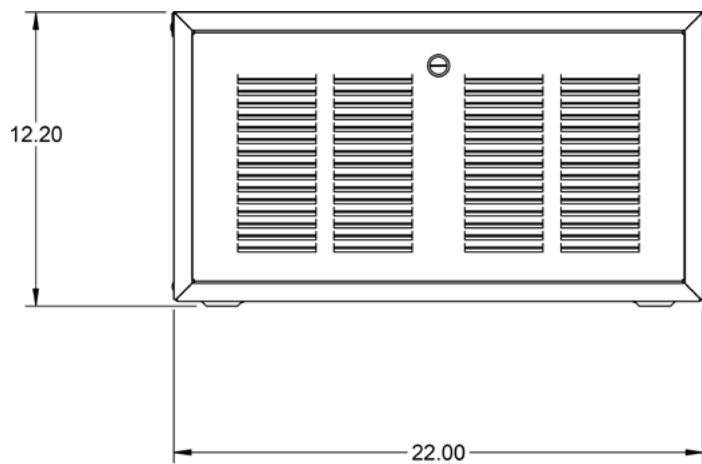

Product Specifications

AM-302220-MTR (16RU)

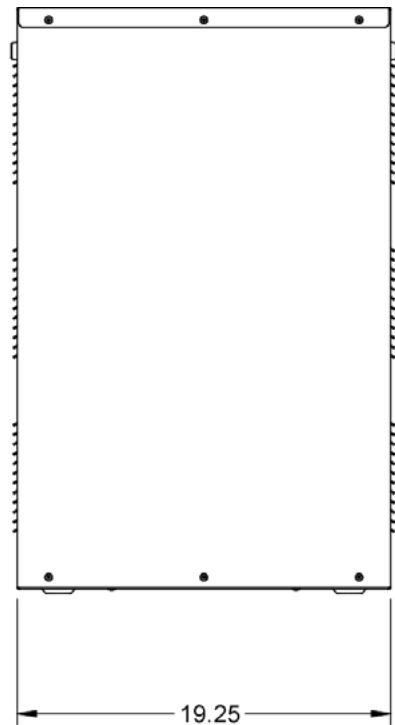
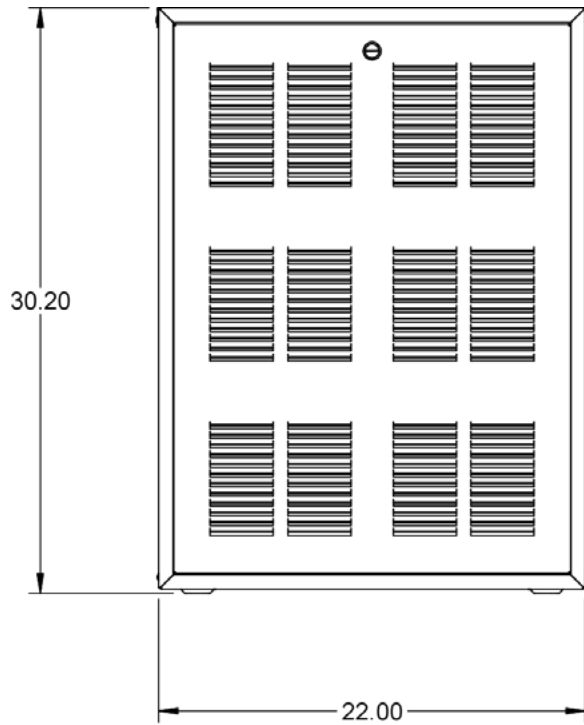

AM-302224-MTR (16RU)

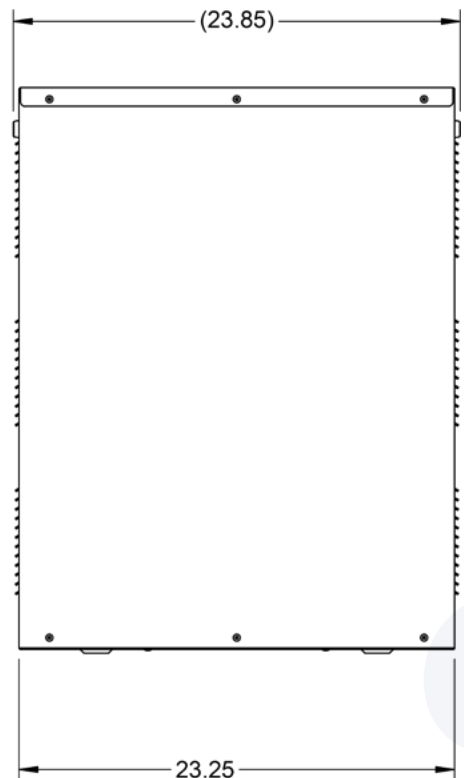
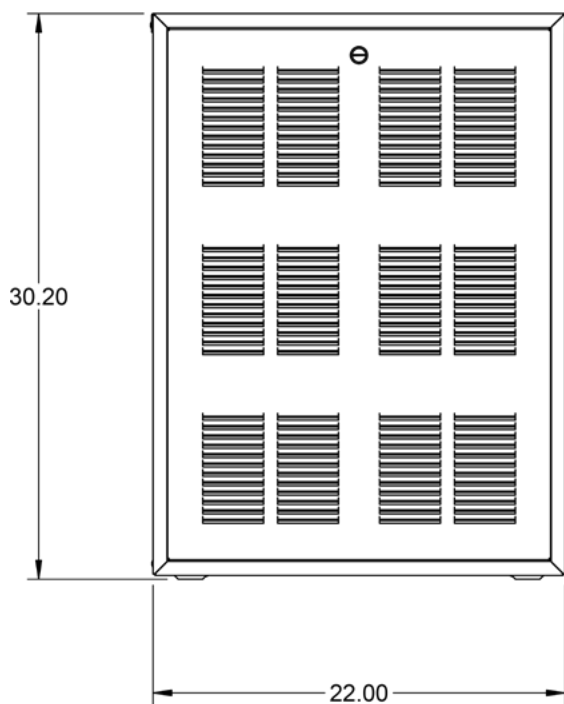

Product Specifications

AM-462220-MTR (24RU)

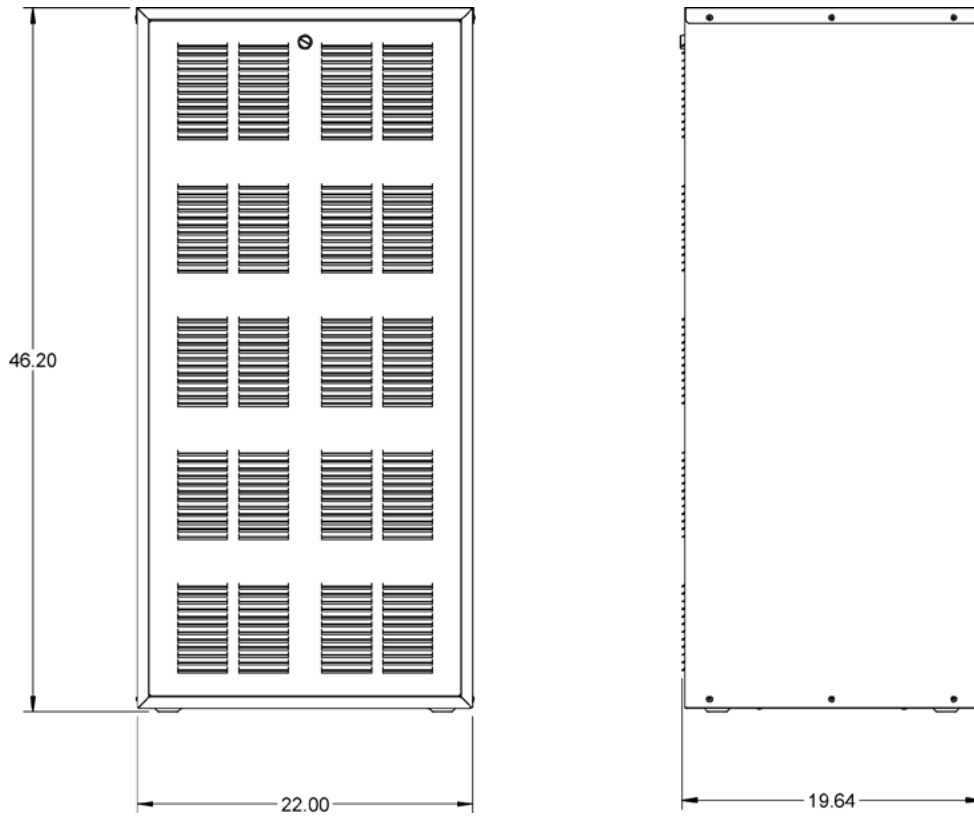

AM-462224-MTR (24RU)

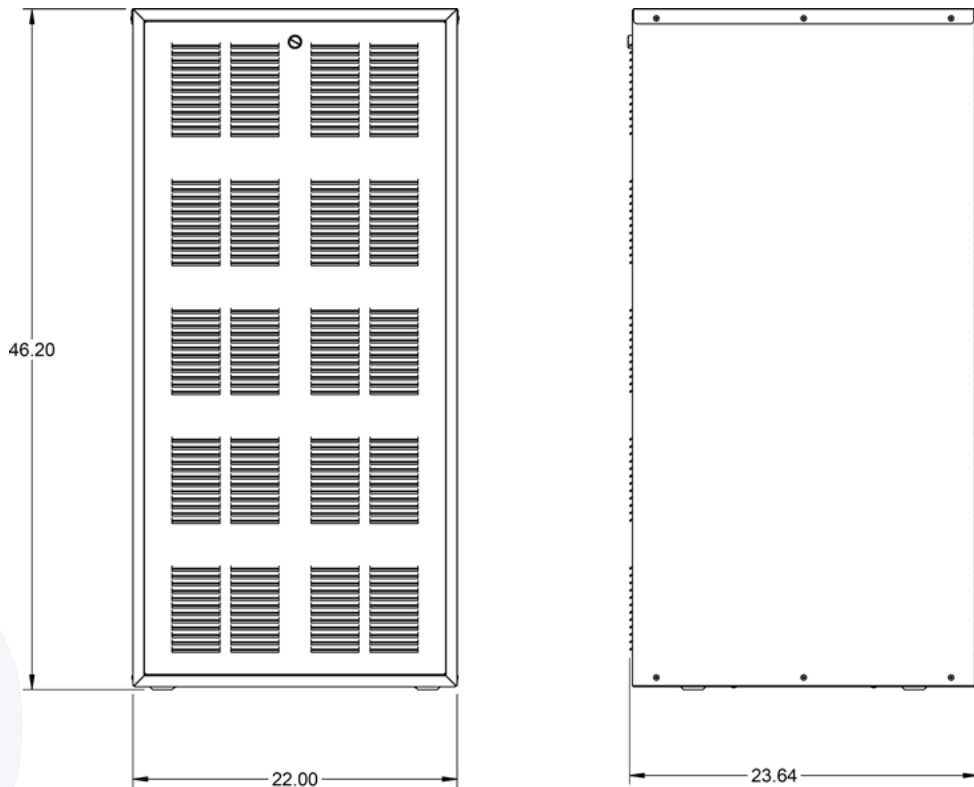

Product Specifications

AM-602220-MTR (32RU)

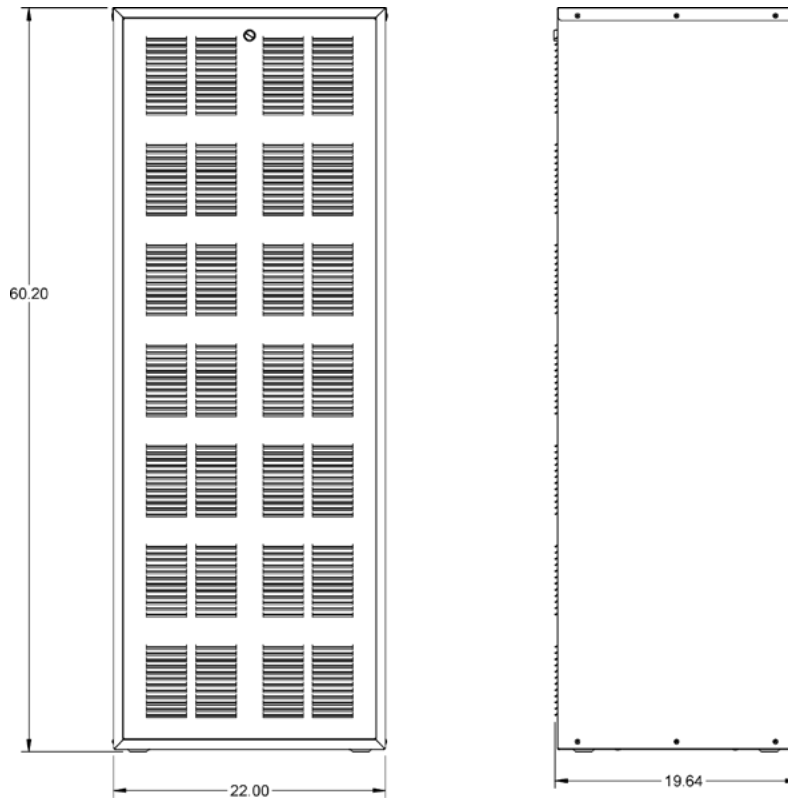

AM-602224-MTR (32RU)

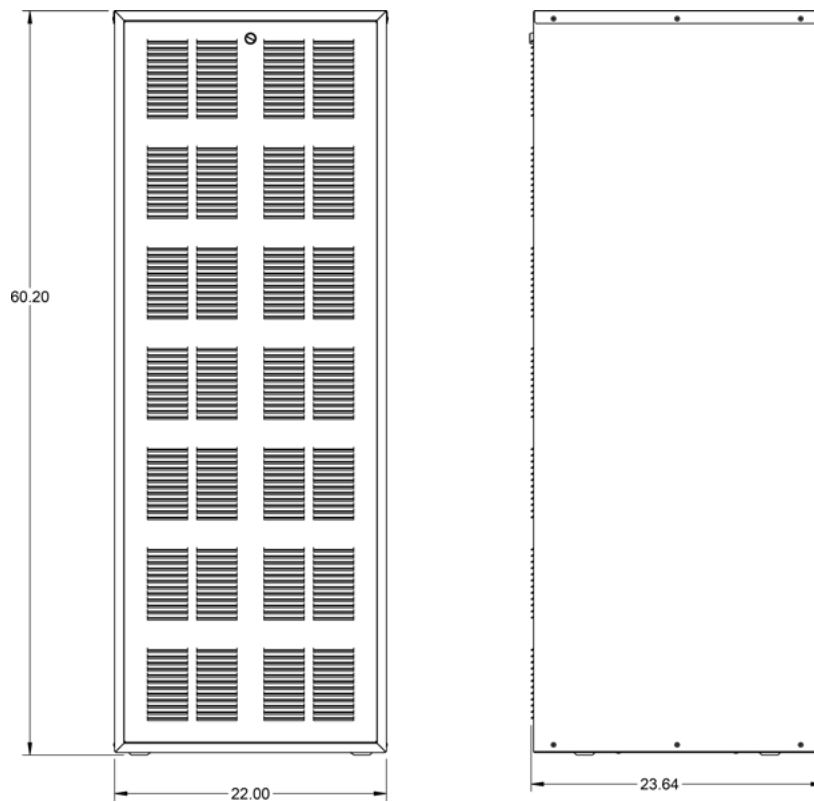

Installation

The AP MINUTEMAN™ cabinet should be mounted on sturdy surface. See the figure below for wall mounting hole patterns.



WARNING

During cabinet mounting, fixture the cabinet securely to avoid personal injury or cabinet damage.

AM-xx2224-MTR

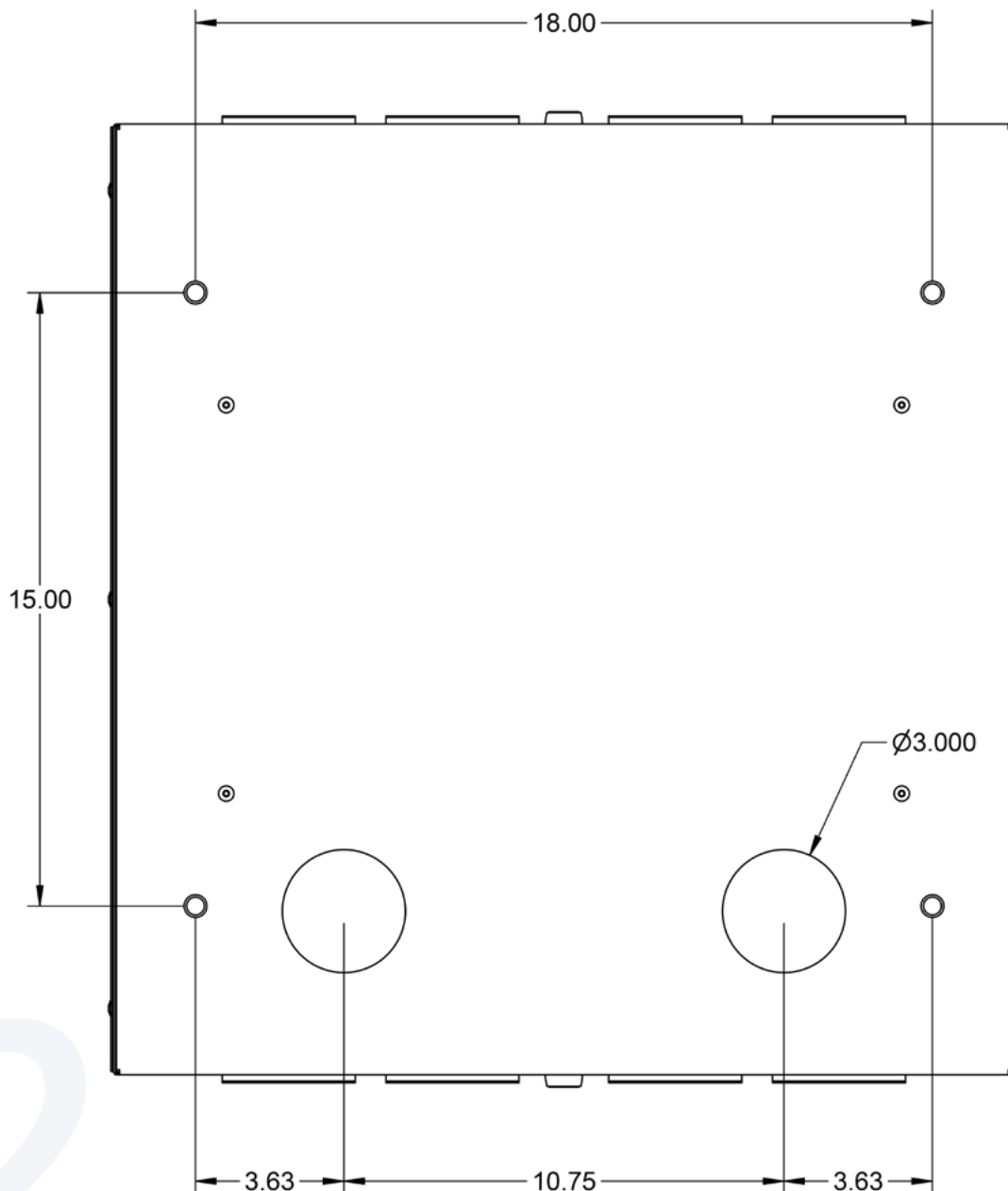

Installation

The AP MINUTEMAN™ cabinet should be mounted on sturdy surface. See the figure below for wall mounting hole patterns.



WARNING

During cabinet mounting, fixture the cabinet securely to avoid personal injury or cabinet damage.

AM-xx2220-MTR

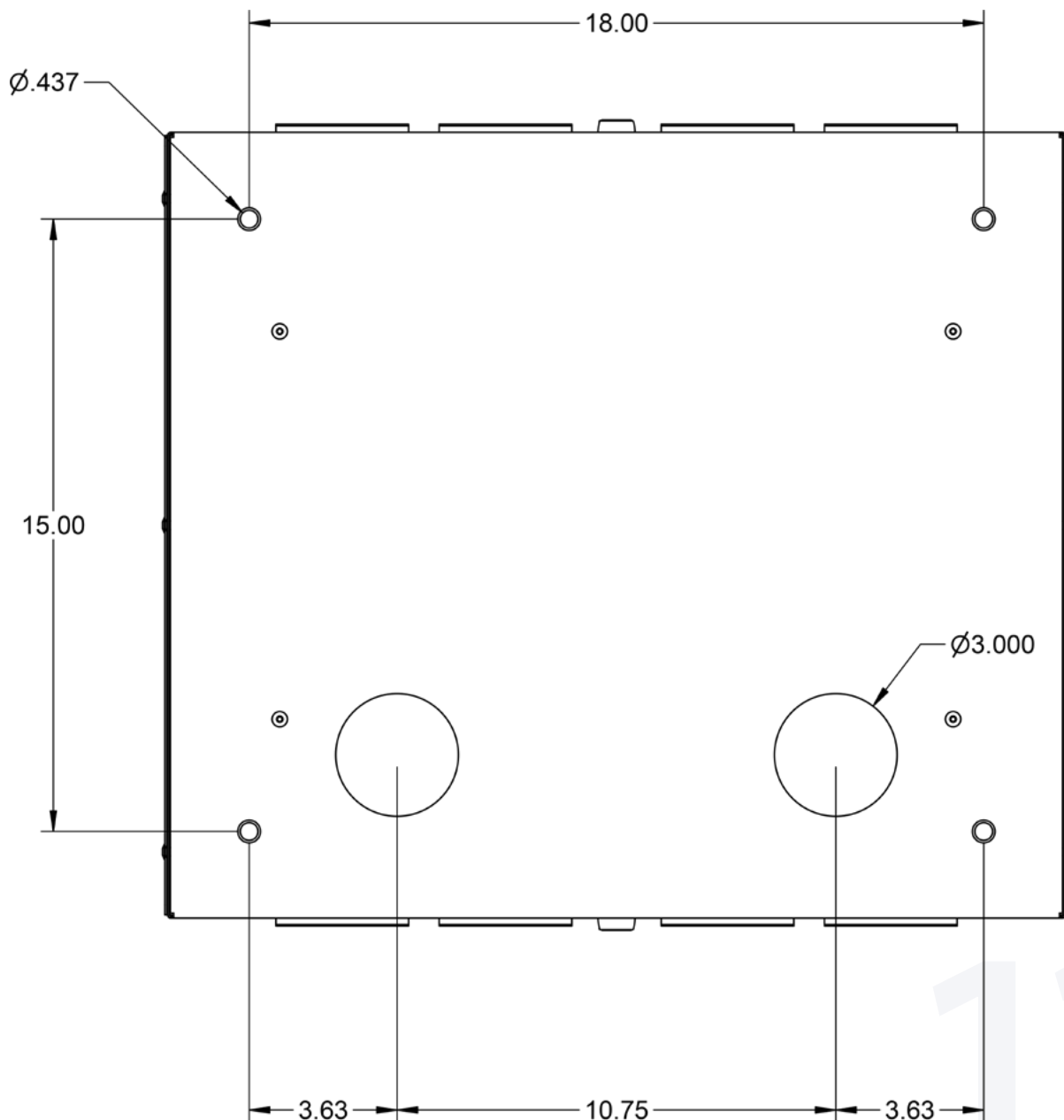

THIS PAGE INTENTIONALLY LEFT BLANK

Appendix A

Technical Support

American Products can be contacted for any issues that arise with the supplied product.

Technical assistance is available 9am to 4pm central standard time.

- Toll Free: (855) 736-2135
- Phone: (417) 736-2135
- Fax: (417) 736-9535
- Email: Sales@amprod.us
- Web: www.amprod.us

When calling, please have available, or if faxing or emailing, be sure to provide:

- Part Number _____
- Serial Number _____
- Date of Purchase _____
- Date of Installation _____

Warranty Policy

Enclosures designed and manufactured by American Products shall be warranted to be free of defects in material or workmanship for a period of 5 years (U.S. & Canada) and 3 years for International deployments from the date of shipment. Should the product be proven to be defective, American Products will have the option to repair or replace the product. Items included with the enclosures, not manufactured by American Products, will carry the original manufacturer's warranty.

It is the responsibility of the buyer to communicate any special environmental concerns in which the enclosures will be utilized. Special materials may be required to allow for proper corrosion resistance for harsh environments. The warranty does not cover enclosures used in applications and environments for which they were not designed. Warranty does not cover abuse, modifications by others or reimbursement for unauthorized rework. At no time will American Products reimburse purchaser for unauthorized rework on any product.

Under no circumstances is American Products liable for any consequential damages, liquidated damages, loss in profits or revenues, costs of capital, downtime costs or damages related to our product performance.

Warranty Claims

Enclosures found to be defective will be repaired or replaced with the same or comparable product. All warranty claims must be communicated to our customer service (855) 736-2135 department to obtain an RMA number. For warranty claims in the USA and Canada, freight will be managed and paid by American Products. For warranty claims outside of the USA and Canada, the customer will be responsible for managing the freight and freight expenses. Products being returned from other than US or Canada are to be returned to the factory in Strafford, MO to receive warranty resolution, once approved with an RMA.

Except for the express warranty stated above, American Products makes no other warranties with respect to the product, expressed or implied, including but not limited to merchantability or fitness for a particular purpose.

AMERICAN[®]
PRODUCTS 
Turn-Key Enclosure Solutions

597 Evergreen Road Strafford, Missouri 65757

Phone: 417-736-2135 Toll Free: 855-736-2135

www.amprod.us