

# AP FORT<sup>®</sup>

Thermal Telecommunications Shelter

*Owner's Manual*



---

## Table of Contents

<b>Contacting Us .....</b>	<b>3</b>
<b>Safety First .....</b>	<b>4</b>
<b>Labeling Information .....</b>	<b>5</b>
<b>Product Overview .....</b>	<b>6</b>
<b>Labeling .....</b>	<b>7</b>
<b>Shelter Packaging .....</b>	<b>8</b>
<b>Lifting Locations .....</b>	<b>9</b>
<b>Installation .....</b>	<b>10</b>
<b>Recommendations for Building Pads .....</b>	<b>16</b>
<b>Electrical .....</b>	<b>18</b>
<b>Maintenance .....</b>	<b>20</b>
<b>Appendix A .....</b>	<b>23</b>
<b>Technical Support .....</b>	<b>23</b>
<b>Warranty Policy .....</b>	<b>23</b>

Contacting Us

American Products can be contacted for any issues that arise with the supplied product.

Technical assistance is available 9am to 4pm central standard time.

- Toll Free: (855) 736-2135
- Phone: (417) 736-2135
- Fax: (417) 736-9535
- Email: [Sales@amprod.us](mailto:Sales@amprod.us)
- Web: [www.amprod.us](http://www.amprod.us)

When calling, please have available, or if faxing or emailing, be sure to provide:



- Part Number \_\_\_\_\_
- Serial Number \_\_\_\_\_
- Date of Purchase \_\_\_\_\_
- Date of Installation \_\_\_\_\_

Safety First

This publication provides a description of the American Products AP FORT® Shelter. The mechanical descriptions, typical applications, installation instructions, safety guidelines, electrical details are included.

Four types of messages may appear throughout this manual, identified by the following icons and signal words:

	Read equipment manufacturer’s manual and this material before using this product. Failure to do so can result in serious injury or death.
---	---

 <b>DANGER</b>	Indicates a hazardous situation that, if not avoided, will result in death or serious injury. This signal word is to be limited to the most extreme situations.
 <b>WARNING</b>	Indicates a hazardous situation that, if not avoided, could result in death or serious injury.
 <b>CAUTION</b>	Indicates a hazardous situation that, if not avoided, could result in minor or moderate injury.
<b>NOTICE:</b>	Indicates information considered important, but not hazard-related (e.g. messages relating to property damage). The safety alert symbol shall not be used with this signal word. When a signal word is used for messages relating to property damage, NOTICE is the choice of signal word.



## Product Overview

The AP FORT® telecommunications shelter is ideally suited for protecting FTTx, wireless communications, power / equipment storage, telecom and other applications and can be easily deployed in remote locations or on top of buildings. The Heavy-Duty Galvanized and Powdered Coated Steel shell protects equipment from inclement weather while the R-11 insulated floor, wall and ceiling helps maintain even temperatures. Optional Air-Conditioners and Heaters are available for a complete environmental protection package.

American Products engineering team will work with you from project inception to completion, making sure your specifications and project goals are met. Our prices are very competitive in the metal building market without sacrificing any of the quality you demand or customer service you expect. From simple to complex, American Products heavy duty steel buildings reduce engineering, procurement and installation costs, keeping your project on time and on budget. Whether your shelter needs include customer installed equipment, or simple electrical requirements, we have the solution.



## Product Overview

- The shelter is constructed of Aluminum & Galvanized Steel with optional powder coat painted or stone aggregate finish for superior corrosion resistance.
- The optional equipment-mounting bays have 19RU of vertical 19" or 23" rack space ea.
- All exterior walls, floor and ceiling are insulated.
- Floor, wall, ceiling and roof panels are bolted construction and made out of 14 gauge galvanized steel. Base is bolted construction and the channels are made from 8 gauge galvanized steel.
- All electrical conduit runs are surface mounted on the interior of the shelter which facilitates easy visual inspection. Interior panels and junctions utilized in standard configurations.
- Formed full height lifting straps on each corner and fork lift tubes in the base to facilitate crane or forklift positioning.
- The Cabinet is designed to allow various accessories to be mounted inside the shelter to meet customer requirements. For part number structure for Parent enclosure and accessories see diagram below:

### PART NUMBERING EXAMPLE

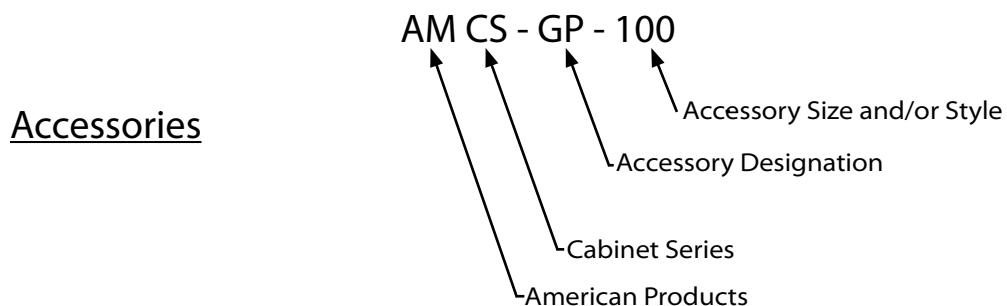
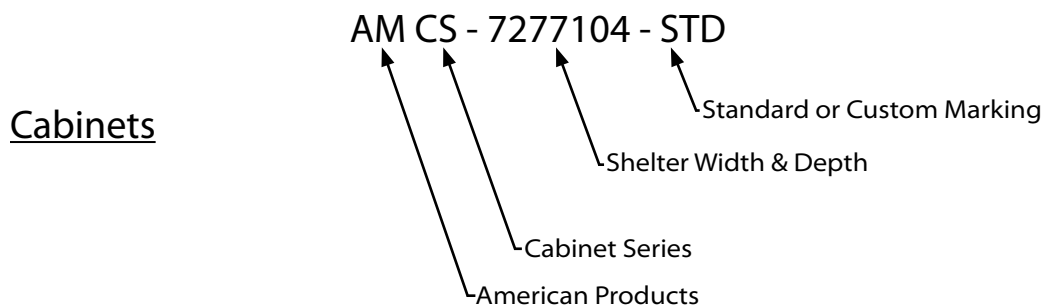

## Labeling Information

The following information will help you locate and decode the labels used on your American Products AP FORT® Shelter.

### Serial Number

The Serial Number, Inspected Date, and Accepted Date can all be found on the hinge side of the door frame. Please provide this information if calling for service or questions.

***Serial Number, Inspected Date, and Accepted Date Label is Located on the Inside of the Top Left Corner of the Door Frame.***

***The Inspection Sticker is Located on the Inside Wall, Adjacent to the Identity Sticker***



### Electrical Labeling

Each light switch and electrical outlet is labeled to enable the user to quickly find the circuit breaker that controls it. For example Label 1 below is a 20A electrical outlet named “L5-20 #6” that is protected by Breaker 19. Label 2 below is a 30A electrical outlet named “L5-30 #1” that is protected by a Dual Pole Breaker in slots 1-3. The third label is a light switch named “Lights” and is protected by Breaker 14.

LC = Load Center

L5-20 #6 LC19	L6-30 #1 LC 1-3	LIGHTS LC14
Label 1	Label 2	Label 3

## Packaging

The American Products *AP FORT*® Shelters are wrapped in a durable plastic sheathing for transportation to prevent abrasions. The sheathing is easily removable using a knife or scissors to cut it away from the shelter.





Lifting Locations

**Lifting Eyes On Each Corner**

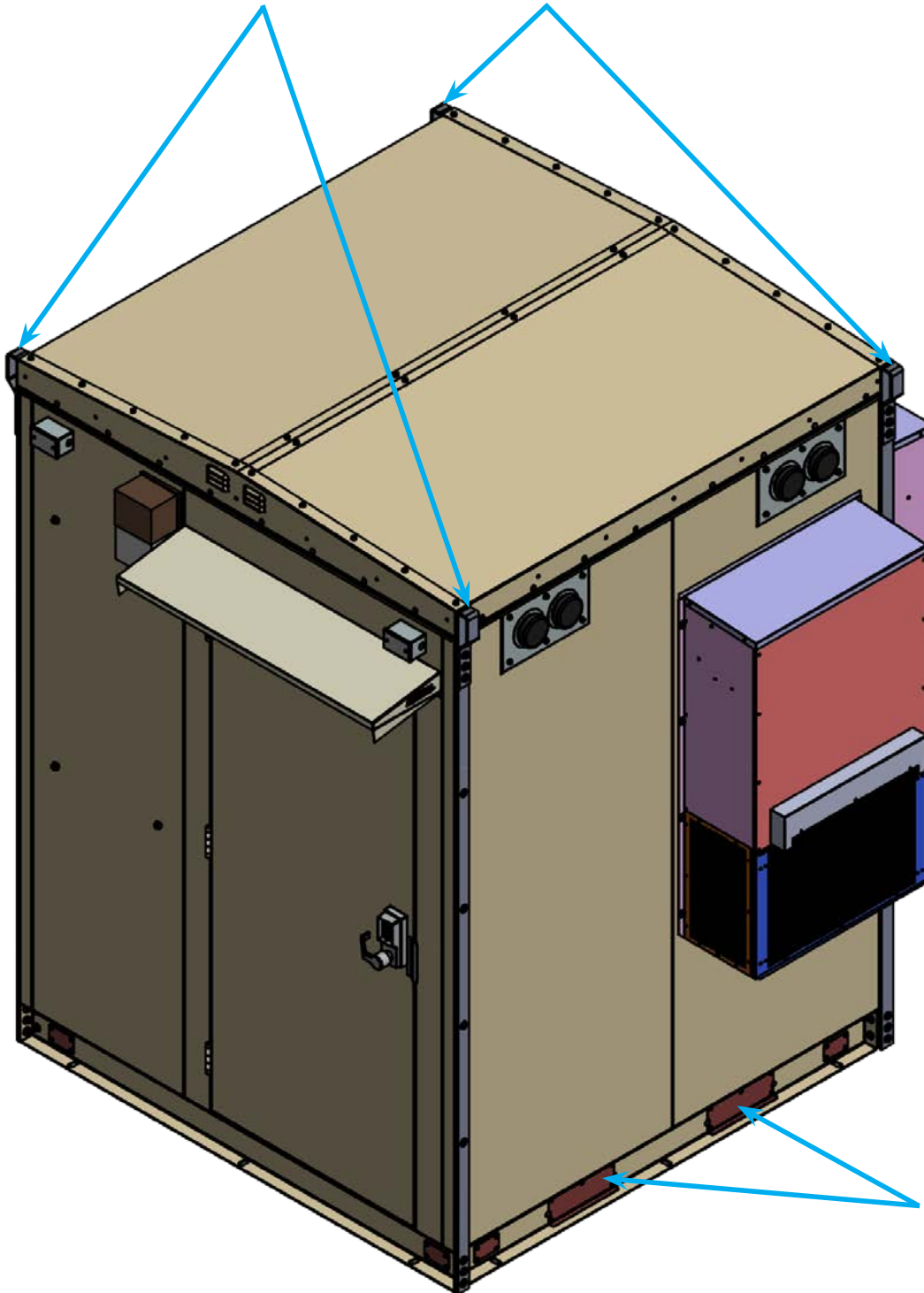

**Fork Lift Tunnels  
on Right and Left  
Side of Shelter**



## Installation Guidelines

The shelter shall always be mounted on a structural pad. Consult with your local municipality. When concrete pad is used it should be a minimum of 6 – 8 inches thick. The recommended anchor hardware size is either (A) Red Head Stainless Steel Trubolt+ ½” diameter x 2” effective anchor depth or (B) Red Head Adhesive anchor using Epcon C6+ adhesive with ½” diameter ASTM F593 stainless steel threaded rod x 2 ¾” effective depth that protrudes 1 ½ inches above the concrete. Always use a spirit level to ensure that the concrete pad is level and flat (within ¼”) from side to side, front to back and diagonally between the corners before mounting Shelter. After mounting Shelter, use a spirit level on the floor of the shelter to ensure it is level from side to side and front to back within ¼” plus check each of the walls for plumb.

The following minimum clearances must be provided to allow for proper operation and maintenance workspace for equipment.

### Front Door Swing

Please allow 37 inches from the front of the Shelter for the Door to swing open.

 <b>DANGER</b>	Crushing Hazard during lifting operations, stand clear of Equipment Shelter, Fork Lift, and Crane. Wear Hard Hats, Safety Glasses, gloves, and steel toe boots. Failure to do so can result in serious injury or death.
 <b>WARNING</b>	Crushing Hazard during lifting operations, use only designated lifting eyes and fork lift tunnels for lifting structure. Failure to do so can result in serious injury or death.
 <b>CAUTION</b>	Crushing Hazard during lifting operations, use equipment capable of lifting the weight of the Shelter plus any equipment that is installed. Failure to do so can result in serious injury or death.
<b>NOTICE:</b>	Equipment Damage during fork lifting operations. Always use forklift on the side away from the air conditioner.

### Installation

The AP FORT® shelter should be mounted on a concrete pad. See the figure below for pad mounting hole patterns.

#### 6 x 6 Shelter

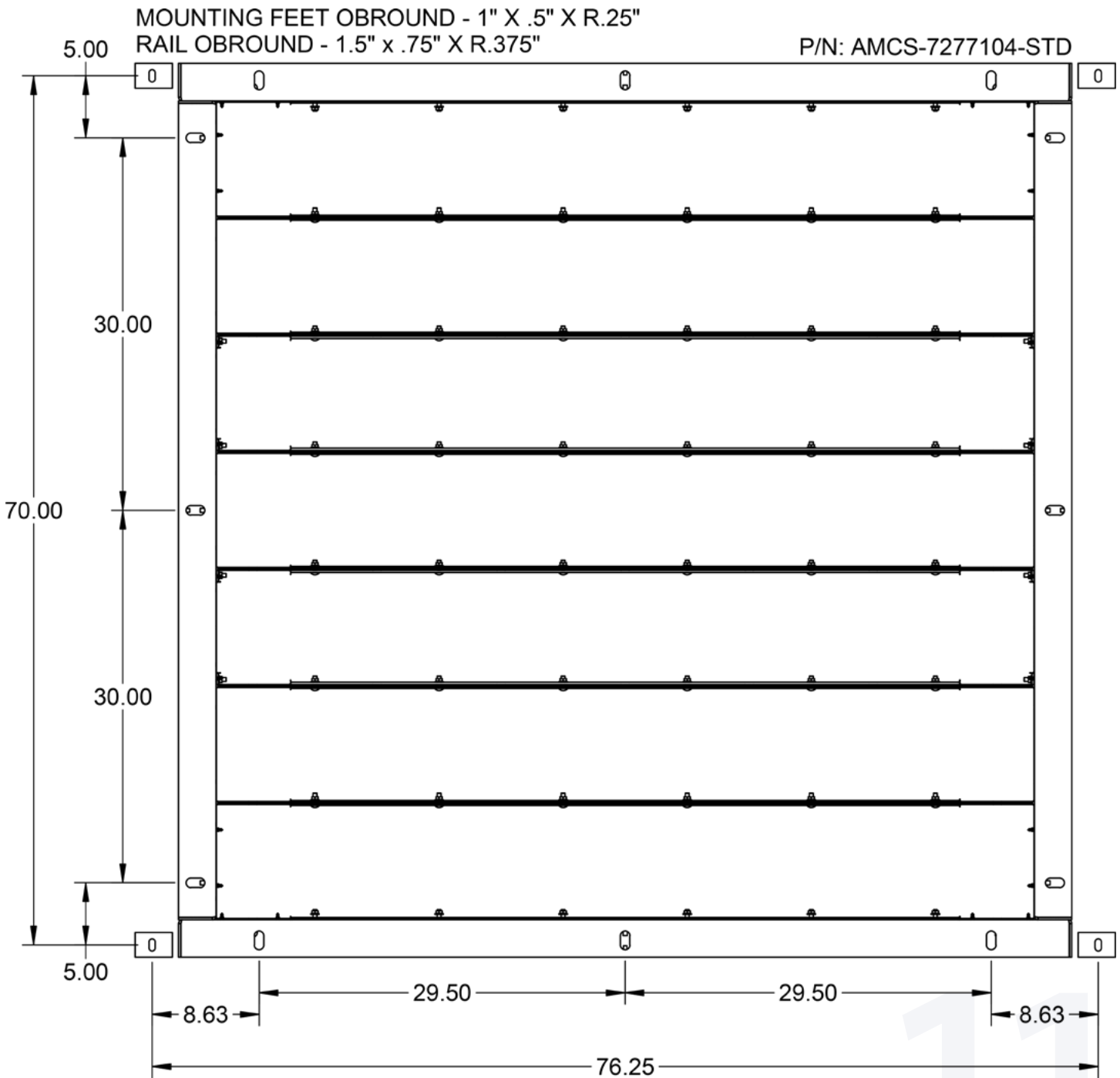

6 x 9 Shelter

MOUNTING FEET OBROUND - 1" X .5" X R.25"  
RAIL OBROUND - 1.5" x .75" X R.375"

P/N: AMCS-10877104-STD

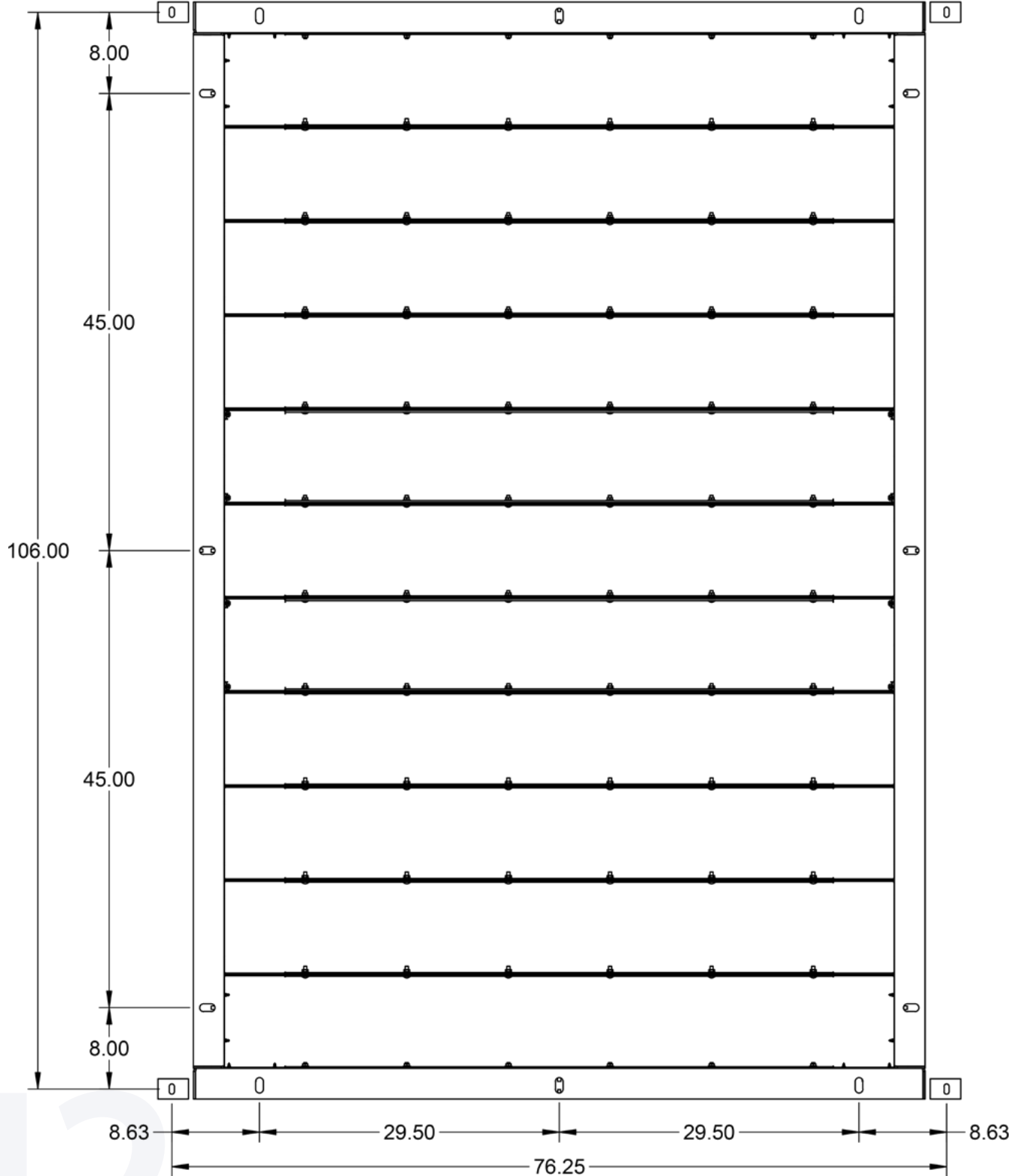

8 x 12 Shelter

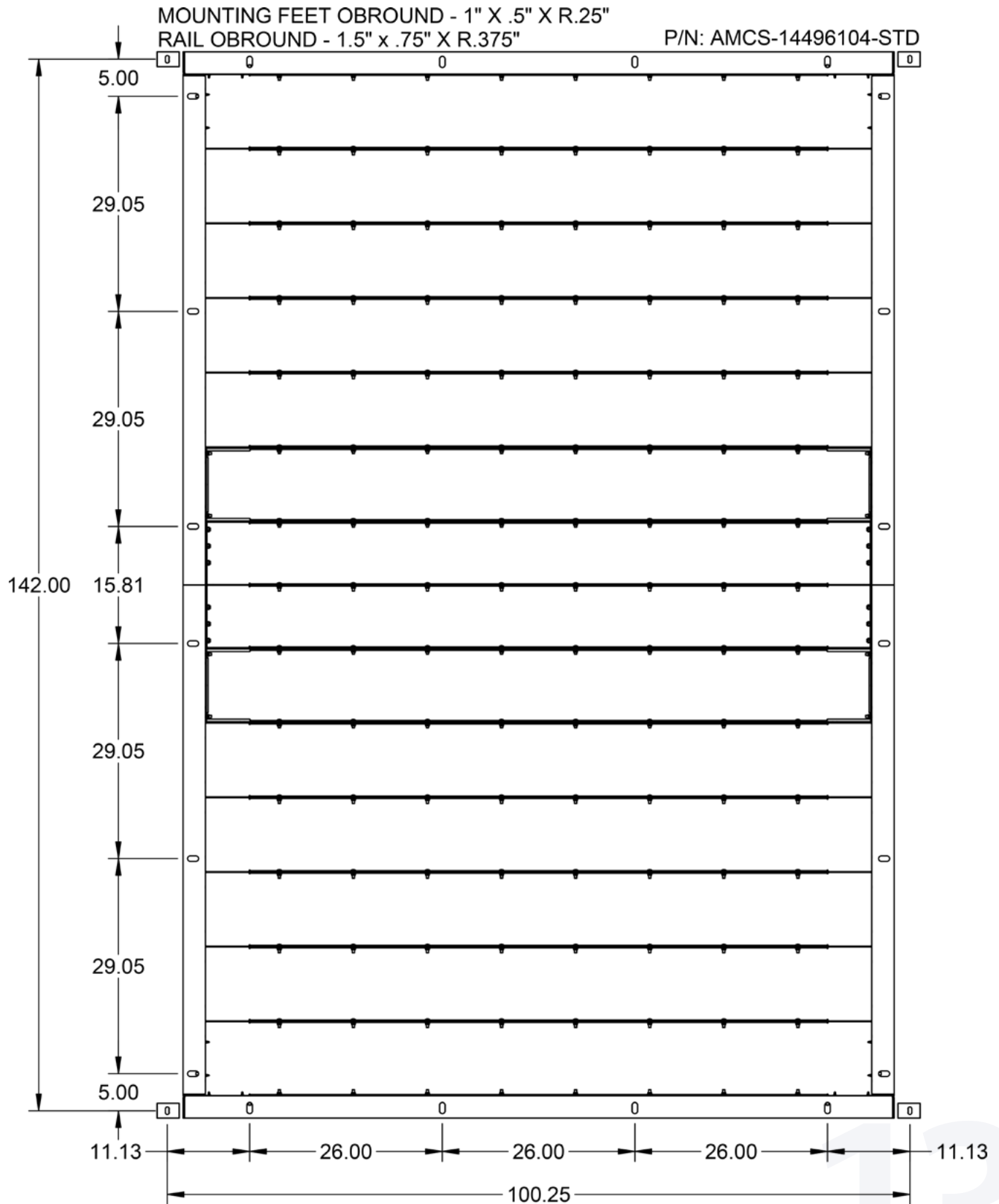

9 x 15 Shelter

MOUNTING FEET OBROUND - 1" X .5" X R.25"

RAIL OBROUND - 1.5" x .75" X R.375"

P/N: AMCS-180108104-STD

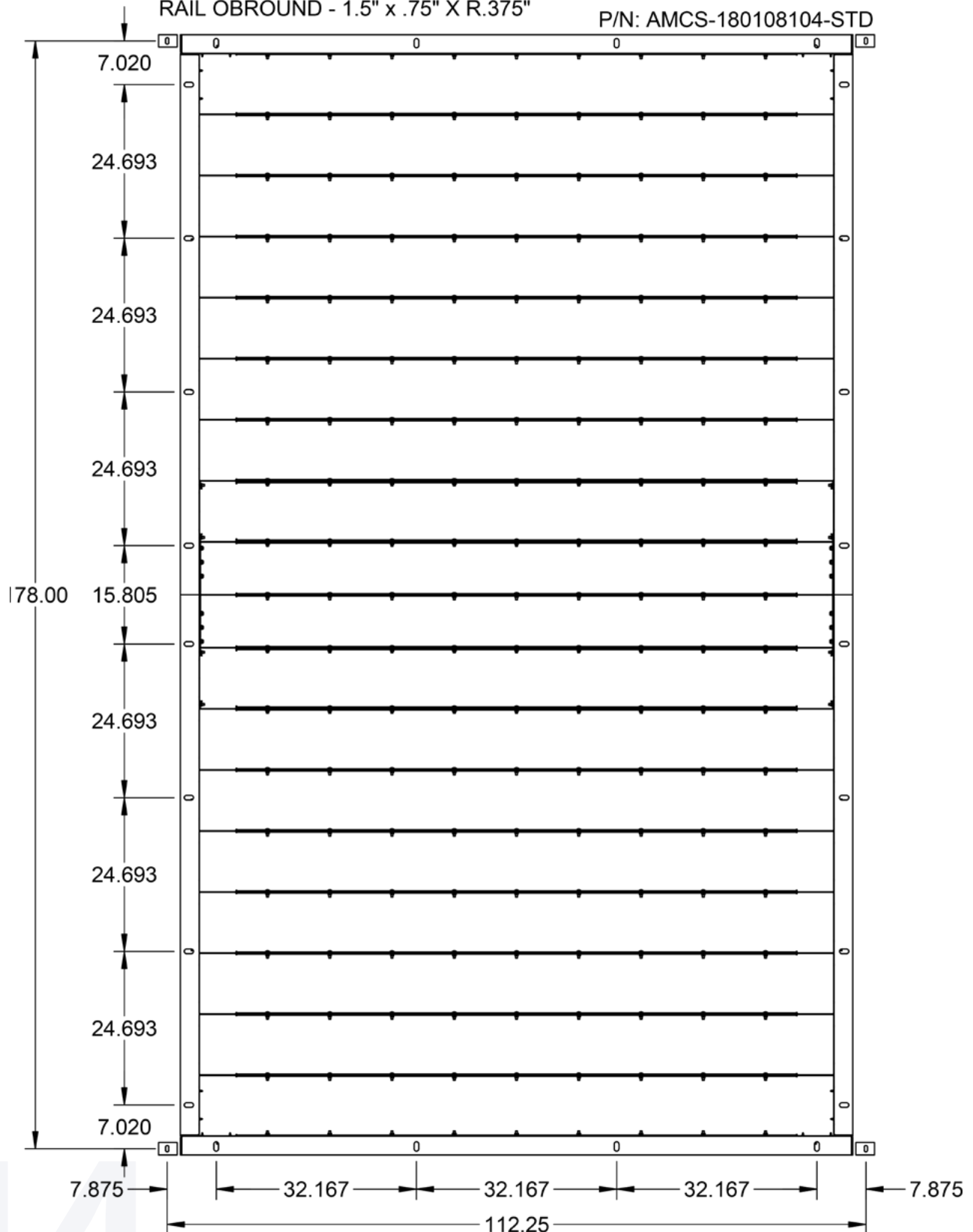

10 x 21 Shelter

MOUNTING FEET OBROUND - 1" X .5" X R.25"

RAIL OBROUND - 1.5" x .75" X R.375"

P/N: AMCS-252120104-STD

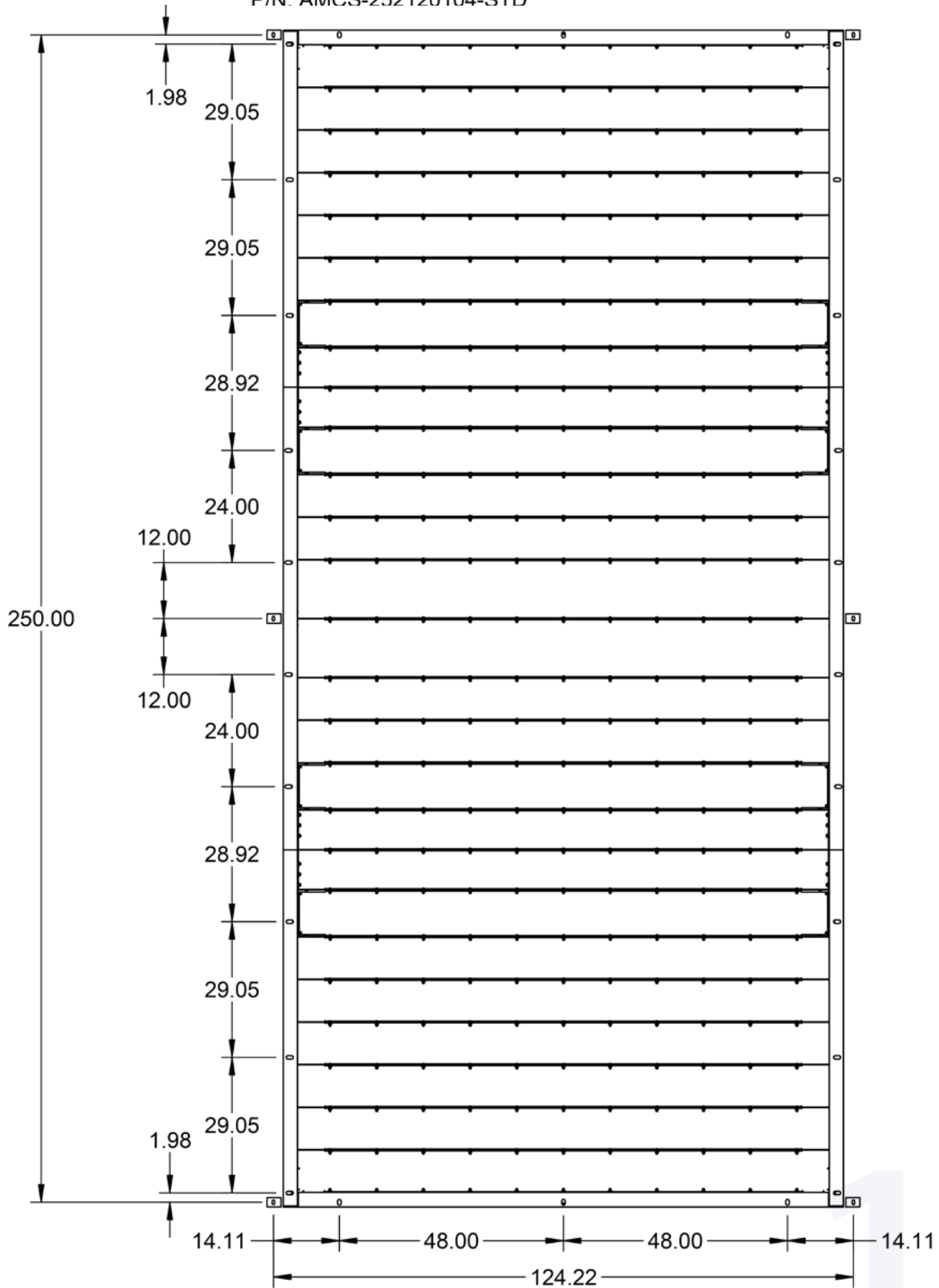

## Recommended References for Building Pads

Building pad should be of six-inch ribbed reinforced concrete construction with proper size spacing to meet the required floor loadings. Increased pad thickness (up to 8") may be required to meet floor live load requirements. Properly reinforced 5000-PSI lightweight concrete should be used for the pad. Concrete ribs will be placed a maximum of 48" on center. Concrete ribs will be of adequate size to resist the loadings applicable of the building design. Reinforcement should be properly placed in the pad panel to provide adequate reinforcement, spacing and cover as required by ACI 318 Building Code Requirements.

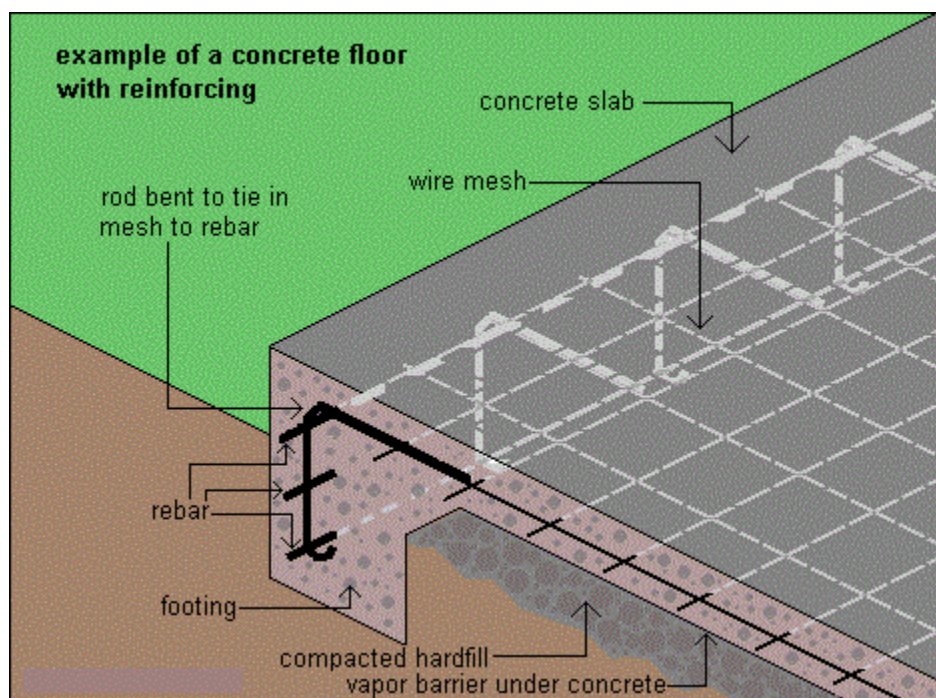

It is recommended that all work should conform to the standards of the applicable code editions:

- International Code Council, including:
  - International Building Code
  - International Fire Code
  - International Plumbing Code
  - International Mechanical Code
  - International Energy Conservation Code
- NFPA 70 National Electrical Code
- Americans with Disabilities Act



## Recommended References for Building Pads

### Reference Standards for Concrete

#### A. American Concrete Institute (ACI)

1. ACI 117, Standard Specifications for Concrete Construction and Materials.
2. ACI 301, Structural Concrete for Buildings
3. ACI 304, Measuring, Mixing, Transporting, and Placing Concrete.
4. ACI 309, Consolidation of Concrete.
5. ACI 318, Building Code Requirements for Reinforced Concrete

#### B. American Society Testing and Materials (ASTM)

1. ASTM A36, Carbon Structural Steel
2. ASTM A82, Steel Wire for Concrete Reinforcement
3. ASTM A108, Steel Bars, Carbon, Cold-Finished, Standard Quality
4. ASTM A153, Zinc Coating (Hot-Dip) on Iron and Steel Hardware
5. ASTM A185, Welded Steel Wire Fabric for Concrete Reinforcement
6. ASTM A497, Welded Deformed Steel Wire Fabric for Concrete Reinforcement
7. ASTM A615, Deformed and Plain Billet-Steel Bars for Concrete Reinforcement
8. ASTM C33, Concrete Aggregates
9. ASTM C150, Portland Cement
10. ASTM C494, Chemical Admixtures for Concrete
11. ASTM C618, Coal Fly Ash for Use as a Mineral Admixture in Concrete

Electrical

 <p><b>WARNING</b></p>	<p>Electrical Shock Hazard: Use appropriate safety equipment such as insulating gloves to avoid electrical shock. Failure to use appropriate procedures could result in serious injury or death.</p>
---	--

<p><b>NOTICE:</b></p>	<p>Electrical work must adhere to the National Electric Code (NEC) and comply with additions and modifications approved by regional and local building code jurisdictions. Any job that involves wiring, circuit breakers, panels, switches, and outlets should always be done by a trained, licensed, and certified electrical contractor.</p>
-----------------------	---

**Bonding and Grounding (if equipped)**

Grounding to Earth Ground should take place before connecting shelter to electrical power source.

Both of the ground bars are isolated from the shell of the shelter via insulators and air gap and the two ground bars are connected via copper ground wire. Connections from Halo Ground to copper grounds to relay racks is accomplished using crimped H-Tap connectors for maximum dependability connections and maintain the unbroken continuity of the Halo.

1. **(Interior Ground Bar)** tin-plated copper ground bar:
  - 12 pairs of 1/4" Stud Holes with 5/8" hole spacing
  - 3 pairs of 3/8" Stud Holes with 1" hole spacing
2. **(Exterior Ground Bar)** Hot-Dip Galvanized Steel ground bar 12" long 4" wide x 1/4" thick:
  - The 12" inch long ground bar offers universal hole spacing for 3/8" (.375")
  - There are twenty seven 7/16" (.4375") OD holes that allow up to 9 runs with two-hole lugs
  - The Universal hole pattern can accepts two-hole lugs with (either .75", .815", or 1")
  - Can be used outdoors or indoors

**NOTE:** Hot-Dipped Galvanizing complies with ASTM A123 & A6 Standards.
3. **(Ground Wire)** Copper ground wire is used between the Interior and Exterior Ground Bars and for the Interior Halo
4. **(Ground Wire to Racks)** from Halo is copper ground wire
5. **(H-Tap)** H-Tap for Halo to branch grounds.

<p><b>NOTICE:</b></p>	<p>Equipment or Property Damage. Ensure all ground connections are properly coated with NO OX to prevent oxidation of the metals which manifests as rust and or corrosion and can cause high resistance connections resulting in diminished high voltage protection and or signaling functions.</p>
-----------------------	---

## Shelter Maintenance

### Powder Coat Metal Surfaces

The frequency of such cleaning will depend on many factors including:

- The geographical location of the building
- The environment surrounding the building, i.e., marine, swimming pool, industrial, or a combination of these environments etc.
- Levels of atmospheric pollution
- Prevailing wind
- Protection of the building by other buildings
- Possibility of airborne debris (e.g. sand/dust etc.) causing erosive wear of the coating
- If the environmental circumstances change during the lifetime of the building (e.g. rural becomes industrial)

The best method of cleaning is by regular washing of the coating using a solution of warm water and mild detergent. All surfaces should be cleaned using a soft cloth or sponge, using nothing harsher than natural bristle brushes. (Cleaning of window sections etc. can be conveniently carried out at the same time as glazing cleaning.) The frequency of cleaning depends in part on the desired standard of appearance and the requirements to remove deposits that could, during prolonged contact with either the powder film or the metal substrate, (if exposed) cause damage. In hazardous environments the normal frequency of cleaning should be at a maximum of three month intervals. However where there is high atmospheric pollution or an extremely hazardous atmosphere (i.e. a combination of factors above or others) the period between cleaning should be reduced.

Where the atmosphere is deemed to be non-hazardous, e.g., rural or a “normal” urban environments, then the period between cleaning can be extended up to a maximum of 12 months. However, if heavy soiling occurs more regular cleaning is required.

The process should be conducted by a professional cleaning contractor and records of all cleaning schedules and frequencies shall be kept and maintained. If the project is subject to any hazardous unusual environmental factors, or is close to salt water, an estuary or marine environments then American Products must be consulted on an individual project basis.

## Shelter Maintenance

<b>Normal Environment (C3)</b>	<b>Clean and check every 12 months</b>
<b>Marine Environment (C4 Coastal)</b>  - 5000m – 2000m from high water level - 2000m – 500m from high water level - 500m – 50m from high water level	Clean and check every 12 months Clean and check every 6 months Clean and check every 3 months
<b>Industrial Environment (C5-I)</b>  - 5000m – 2000m from source - 2000m – 500m from source - 500m – 50m from source	Clean and check every 12 months Clean and check every 6 months Clean and check every 3 months

**Do not under any circumstances use strong solvents or solutions containing:**

*Chlorinated Hydrocarbons*

*Esters*

*Ketones*

*Abrasive Cleaner or polish*

## MELAMINE Panel Care

Your MELAMINE panels are manufactured from the highest quality materials and designed to provide years of trouble free service. As with any wood based panel cannot be made totally waterproof, care should be taken to wipe up spills immediately, ensuring the Panels are not exposed to high or continuous levels of moisture, steam and humidity.

General Cleaning: Using a mild spray, wipe down the panel with a soft cloth taking care not to rub too hard. Dry using a soft cloth so as not to leave any residue on the panel. You may also use Methylated Spirit on a soft cloth, using a circular cleaning motion. Thoroughly clean over the wider area with water and detergent on a damp cloth afterwards to remove any residual Methylated Spirit.

Always ensure that you refer to the recommendations provided by the cleaning product manufacturer before use.

## Shelter Maintenance

DO NOT use any of the following on the MELAMINE panels: Commercial Cleaning Products, Abrasive Cleaners, Scouring Pads or Abrasive Papers, Acids and Alkalis, Solvents, Thinners, Turpentine (Turps), Ammonia, Bleach, Acetone, Easy-Off BAM!, M.E.K. or any other cleaning agents containing organic solvents or the above mentioned products.

### **Aggregate panel care**

Aggregate panels are lightweight yet strong with high impact resistance and are suitable for both interior and exterior applications. The panels are maintenance free, unaffected by climatic extremes, impervious to moisture, chemical resistant and will not delaminate under any conditions. They are inorganic, rot proof, immune to attack by insects and vermin, and will not nourish mold growth.

Panels can be installed year round and are compatible with all common building materials. No significant change in properties occurred following accelerated weathering testing giving the equivalent to seven years exposure.

### **Vinyl Tile Floor Care and Maintenance**

Proper care and maintenance will help ensure your floor always looks its best. Simply follow our maintenance and prevention steps outlined below.

#### Proactive Protection for Your Floor

- When moving appliances or heavy furniture, it is always wise to lay a plywood panel on your floor and “walk” the item across it. This protects your floor from scuffing and tears.
- Use floor protectors to reduce indentation. As a general rule of thumb, the heavier the item, the thicker the floor protector needed.
- Be careful with rolling casters. They can damage the floor. Therefore, we do not recommend them. If you choose to use them, the double-wheel type is the best option.
- Place a walk-off mat at outside entrances to reduce the amount of dirt brought into your home. We strongly recommend mats without a latex or rubber backing since these backings can cause permanent discoloration.

## Shelter Maintenance

### Caring for Your Floor

- Sweep or vacuum regularly to remove loose dirt which can scratch your floor. NOTE: We do not recommend vacuums that have a beater bar since it can visibly damage your flooring surface. Additionally, we do not recommend electric brooms with hard plastic bottoms with no padding as use may result in discoloration and de-glossing.
- Wipe up spills as soon as possible. Never use highly abrasive scrubbing tools on any resilient floor.
- Wash your floor regularly with a floor cleaner.
- Do NOT use detergents, abrasive cleaners, or “mop and shine” products. These products may leave a dull film on your floor.
- Over time, if the shine on your floor begins to dull, floor polish can be used to renew your floor’s shine. Do NOT use paste wax or solvent-based polishes.

## Appendix A

### Technical Support

American Products can be contacted for any issues that arise with the supplied product.

Technical assistance is available 9am to 4pm central standard time.

- Toll Free: (855) 736-2135
- Phone: (417) 736-2135
- Fax: (417) 736-9535
- Email: [Sales@amprod.us](mailto:Sales@amprod.us)
- Web: [www.amprod.us](http://www.amprod.us)

When calling, please have available, or if faxing or emailing, be sure to provide:

- Part Number \_\_\_\_\_
- Serial Number \_\_\_\_\_
- Date of Purchase \_\_\_\_\_
- Date of Installation \_\_\_\_\_

### Warranty Policy

Enclosures designed and manufactured by American Products shall be warranted to be free of defects in material or workmanship for a period of 5 years (U.S. & Canada) and 3 years for International deployments from the date of shipment. Should the product be proven to be defective, American Products will have the option to repair or replace the product. Items included with the enclosures, not manufactured by American Products, will carry the original manufacturer's warranty.

It is the responsibility of the buyer to communicate any special environmental concerns in which the enclosures will be utilized. Special materials may be required to allow for proper corrosion resistance for harsh environments. The warranty does not cover enclosures used in applications and environments for which they were not designed. Warranty does not cover abuse, modifications by others or reimbursement for unauthorized rework. At no time will American Products reimburse purchaser for unauthorized rework on any product.

Under no circumstances is American Products liable for any consequential damages, liquidated damages, loss in profits or revenues, costs of capital, downtime costs or damages related to our product performance.

### Warranty Claims

Enclosures found to be defective will be repaired or replaced with the same or comparable product. All warranty claims must be communicated to our customer service (855) 736-2135 department to obtain an RMA number. For warranty claims in the USA and Canada, freight will be managed and paid by American Products. For warranty claims outside of the USA and Canada, the customer will be responsible for managing the freight and freight expenses. Products being returned from other than US or Canada are to be returned to the factory in Strafford, MO to receive warranty resolution, once approved with an RMA.

Except for the express warranty stated above, American Products makes no other warranties with respect to the product, expressed or implied, including but not limited to merchantability or fitness for a particular purpose.

**AMERICAN<sup>®</sup>**  
**PRODUCTS**   
*Turn-Key Enclosure Solutions*

597 Evergreen Road Strafford, Missouri 65757

Phone: 417-736-2135 Toll Free: 855-736-2135

[www.amprod.us](http://www.amprod.us)